

**TECHNICAL SPECIFICATION SHEET:**
**UNIPAS - S PALLET - EU**

<b>DESCRIPTION:</b>		<b>Pallet made of S 235 structural steel, welded, hot dip galvanized</b>
<b>EXTERNAL DIMENSIONS:</b>	<b>(W794xL1193xH132mm)</b>	<b>KEY FEATURES:</b>
<b>EMPTY WEIGHT:</b>	<b>36 kg</b>	<ul style="list-style-type: none"> <li>-4-WAY ENTRY DESIGN,HIGH LOAD CAPACITY</li> <li>-GREAT STABILITY AND STACKABILITY-CORNER STOPS</li> <li>-RESILIENCE AND ROBUSTNESS-EXTRA DURABLE</li> <li>-100% RESISTANCE TO CORROSION AND ATMOSPHERIC AGENTS</li> <li>-EASY TO STERILIZE-NO MOLDS,NO VERMIN,NO CONTAMINATION</li> <li>-FULL FIRE RESISTANCE</li> <li>-FULL RECYCLABILITY</li> </ul>
<b>DYNAMIC LOAD:</b>	<b>2500 kg *</b>	
<b>STATIC LOAD:</b>	<b>7500 kg *</b>	
<b>STANDARD COLOR:</b>	<b>UNIFORM SOFT GRAY</b>	
<b>MATERIAL:</b>	<b>S 235 STEEL,HOT DIP GALVANIZED</b>	
<b>WORKING TEMPERATURE:</b>	<b>-40+80°C</b>	
<b>STANDARD TRAILER:</b>	<b>640 units</b>	<b>FIELDS OF APPLICATION:</b>
<b>MEGA TRAILER:</b>	<b>640 units</b>	<b>CHEMICAL INDUSTRY-</b> HARSH ENVIRONMENTS AND SAFE USE IN CHEMICAL PRODUCTION & STORAGE
<b>20 GP:</b>	<b>187 units</b>	<b>FOOD TRANSPORT AND HANDLING-</b> EASY TO CLEAN AND STERILIZE,NO CONTAMINATION
<b>40 GP:</b>	<b>408 units</b>	<b>HEAVY CONSTRUCTS-</b> EXCELLENT FOR LARGE AND HEAVY ITEMS
<b>40 HC:</b>	<b>476 units</b>	<b>LONG-TERM OUTDOOR STORAGE-</b> WEATER RESISTANCE,NO DEGRADATION

**DISCLAIMER:**

**\* Subjected to internal Unipas statical and dynamical testing.  
 The suitability of application is to be consulted with Unipas.  
 Specifications subject to change without further notice.  
 All dimensions approximate.**

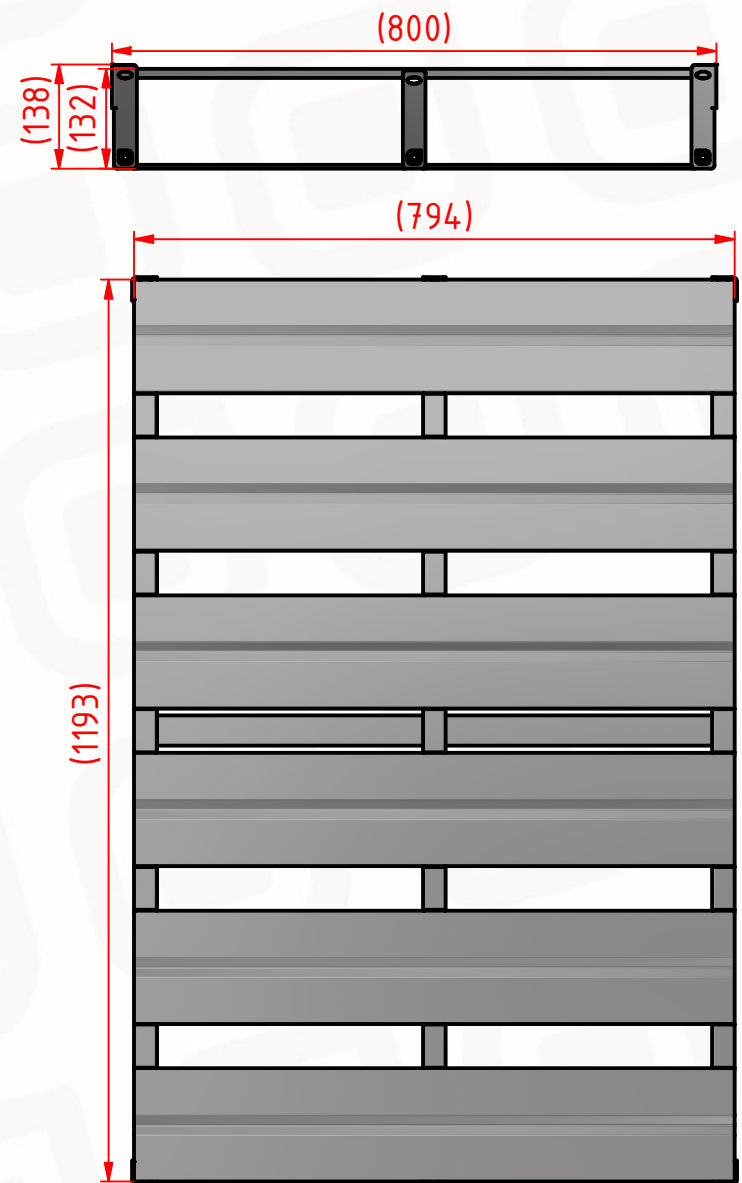
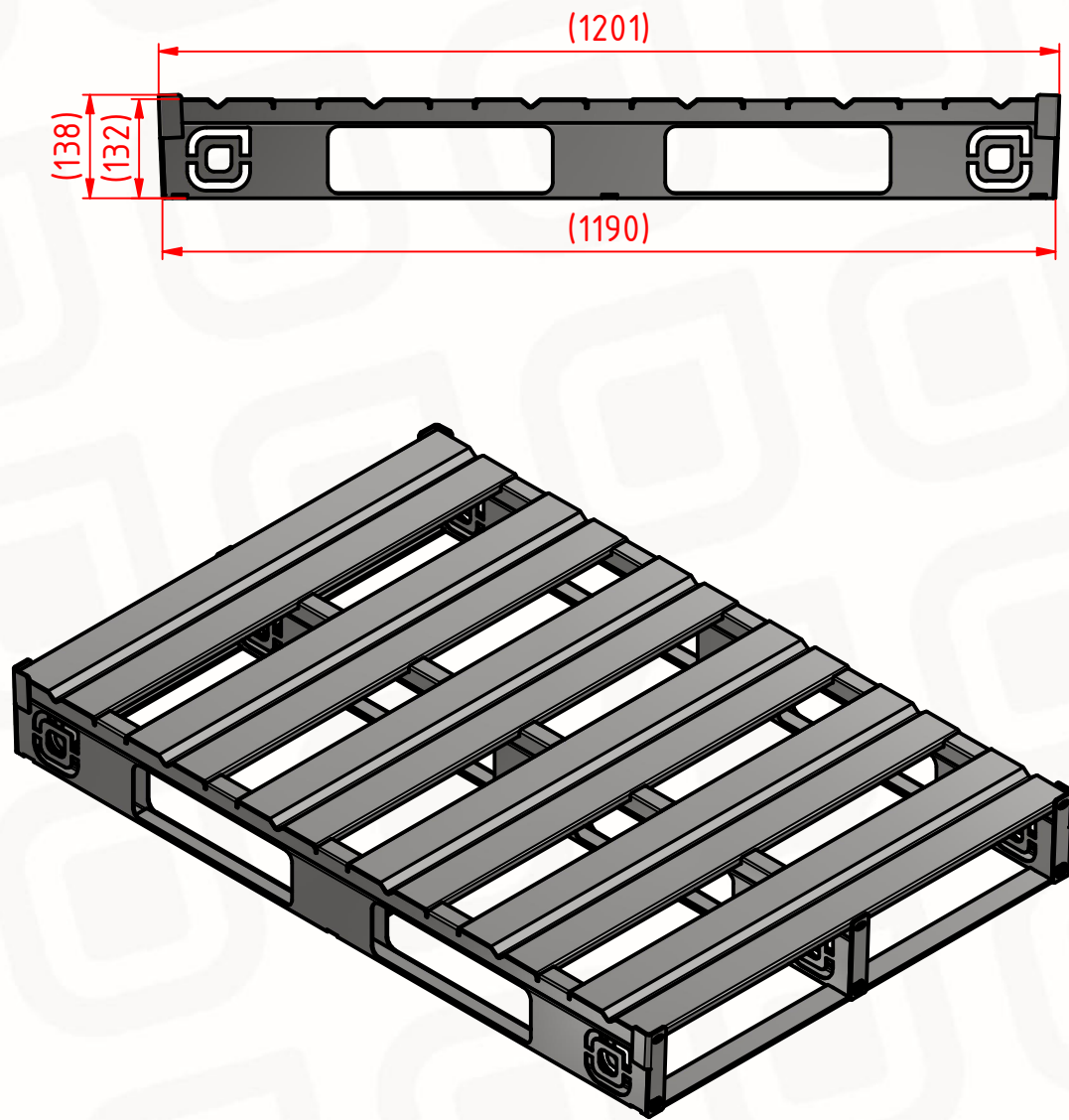